



*Fluid Handling
Innovation*

SelfService
MC
MANAGEMENT
SYSTEM
SOFTWARE



**MADE
IN
ITALY**

Use and Configuration

EN

BULLETIN MOO87 B_00 EN CD

1	WHAT IS MC	3
2	SUMMARY OF MC PERFORMANCES	3
2.1	ACCESS CONTROL	3
2.2	USERS	3
2.3	CONFIGURATION PROCEDURES	3
2.4	MANAGEMENT ACTIVITIES	3
2.5	FUEL DISPENSING	3
2.6	DATA MANAGEMENT ON PC (OPTIONAL)	4
2.7	TANK LEVEL MONITORING	4
3	HOW DOES MC WORK?	4
3.1	OPERATING MODES	4
3.2	DISPLAYS	5
3.3	KEYPAD	5
3.4	ELECTRONIC KEYS AND KEY READER	6
4	HOW TO USE MC	6
4.1	GENERAL INFORMATION	6
4.1.1	GRAPHIC REPRESENTATION OF MC SOFTWARE	7
4.1.2	SOFTWARE OVERVIEW	8
4.2	BOOT	10
4.3	ALARM MANAGEMENT	10
4.4	ACCESS CONTROL	11
4.5	SYSTEM CONFIGURATION	11
4.5.1	INSTALLATION CONFIGURATION	11
4.5.2	CHANGING CONFIGURATION	13
4.6	SYSTEM MANAGEMENT	16
4.6.1	REPORT	16
4.6.1.1	REPORT / TRANSACTION	16
4.6.1.2	REPORT / USERS	18
4.6.1.3	REPORT / CONFIGURATION	18
4.6.1.4	REPORT / TOTALS	19
4.6.2	USERS	21
4.6.2.1	USERS / ADD	21
4.6.2.2	USERS / DELETE	22
4.6.2.3	USERS / PRINT	23
4.6.2.4	USERS / VIEW	23
4.6.3	SYSTEM	24
4.6.3.1	SYSTEM / SERIAL NUMBER	24
4.6.3.2	SYSTEM / MEMORY	24
4.6.3.3	SYSTEM / DATA / TIME	24
4.6.3.4	SYSTEM / BUZZER	24
4.6.4	CHECK KEY	24
4.6.5	CALIBRATION	26
4.6.5.1	CALIBRATION VIEW	26
4.6.5.2	CALIBRATION / MODIFY	26
4.6.6	DATA TRANSFER	28
4.7	DISPENSING	30
4.7.1	WARNING MESSAGES	30
4.7.2	OPTIONAL INPUT	30
4.7.3	DISPENSING	30
4.7.4	DISPENSING A PRESET QUANTITY	31

1 WHAT IS MC?

MC is an ELECTRONIC SYSTEM incorporated in SELF SERVICE MC stations, which controls the distribution of Diesel fuel.

Its main features are:

- a complete range of performances at Manager's disposal in Configuration and Data Management stages;
- easy fuel dispensing for Users.

2 SUMMARY OF MC PERFORMANCES

2.1 ACCESS CONTROL

MC allows access to enabled USERS exclusively.

MC can recognize an enabled User by entering a PIN CODE (4 figures).

2.2 USERS

According to the access level two kinds of USERS can be identified:

- THE MANAGER - ONE for each MC system -
He is associated with a MASTER PIN CODE;
- THE USER – up to 80 users for each MC system –
Each user is associated with a different USER PIN CODE.

ATTENTION

All MC systems are delivered with MASTER PIN CODE = 1234 which can be modified by the Manager later. Should the selected or default MASTER PIN CODE be forgotten, no access to Manager's activities will be possible. In this case the Manager can ask our SERVICE for the "SUPER MASTER CODE" which gives access to the forgotten MASTER CODE.

Each MC system has its own SUPER MASTER CODE which can not be modified. For this reason you are recommended to keep it absolutely secret.

2.3 CONFIGURATION PROCEDURES

The configuration procedures are accessible exclusively by the MANAGER, who can tailor the use of SELF SERVICE MC to his specific requirements.

Configuration procedures include:

- definition of installation name;
- request for optional input (vehicle registration number and/or odometer value);
- time out length at beginning and end of delivery;
- printer features and automatic printout type (ticket or data logging);
- choice of unit of measurement;
- connection to PC to collect data;
- modification of MASTER CODE.

2.4 MANAGEMENT ACTIVITIES

The management activities are accessible exclusively by the MANAGER, who can control the use of the SELF SERVICE MC station.

Management activities include:

- printing delivery reports (different types);
- printing user list;
- printing system configuration;
- enabling/disabling users;
- controlling system data (storage / data / time);
- calibrating fuel meter installed on SELF SERVICE unit.

2.5 FUEL DISPENSING

Access to fuel dispensing is allowed to USERS exclusively. Fuel is supplied:

- after asking the user to enter his vehicle REGISTRATION NUMBER or any other numbers or letters for registration purposes;
- after asking the user to enter the ODOMETER value of the vehicle;
- after allowing the user to PRESET the amount of fuel to be delivered;
- After delivery, the remote printer (if any) can issue a TICKET showing all delivery data.

2.6 DATA MANAGEMENT ON PC (OPTIONAL)

Delivery data, collected and stored in the non-volatile memory of the MC unit, can be collected and transferred to a PC to be managed more easily and effectively and be kept for longer periods of time.

Data management requires a special software, the SELF SERVICE, to be installed on the PC. Data can be transferred from MC to a PC by means of a wired connection in RS 485.

2.7 TANK LEVEL MONITORING

SELF SERVICE MC offers a LEVEL ALARM input which can be connected to an external level indicator and interfaced directly with MC to:

- print a low level WARNING on the ticket of the remote printer;
- STOP fuel delivery.

3

3

HOW DOES MC WORK?

3.1 OPERATING MODES

A large number of OPERATING MODES are available, which MC enters automatically when particular events occur.

- **SYSTEM mode**
In this mode MC carries out all operations connected with access control and system management. When in this mode MC asks for and accepts INPUT from the keypad and supplies OUTPUT on the display or on the printer.
- **DISPENSING mode**
In this mode fuel is delivered. Exit from this mode requires STOP key to be pressed, or a preset quantity to be supplied, or no delivery to be effected for a certain amount of time.
- **MANUAL mode**
In this mode fuel can be delivered OVERRIDING MC OPERATION. MANUAL mode shall be used as an exception when fuel is dispensed without recording the operation (for management reasons), and/or to simplify repeated pump starting at start-up stage or during maintenance.

ATTENTION:
In MANUAL mode MC can not record any data concerning deliveries carried out.

To enter this mode act as follows:

- unlock SELF SERVICE front door;
- unscrew MC Box panel to access the electronic cards;
- move the jumper from its present position (default position: it bridges the 2 upper contacts in AUTO mode) to a lower position, that is it must bridge the 2 lower contacts.

In MANUAL mode:

- MC LCDs can be off or continue showing the information displayed on changing mode (from AUTO to MAN);
- no PIN CODE is required to activate the pump; it will start as soon as the nozzle is extracted from its seat and stop when the nozzle is put back;
- no indication of fuel quantity delivered by SELF SERVICE can be obtained.

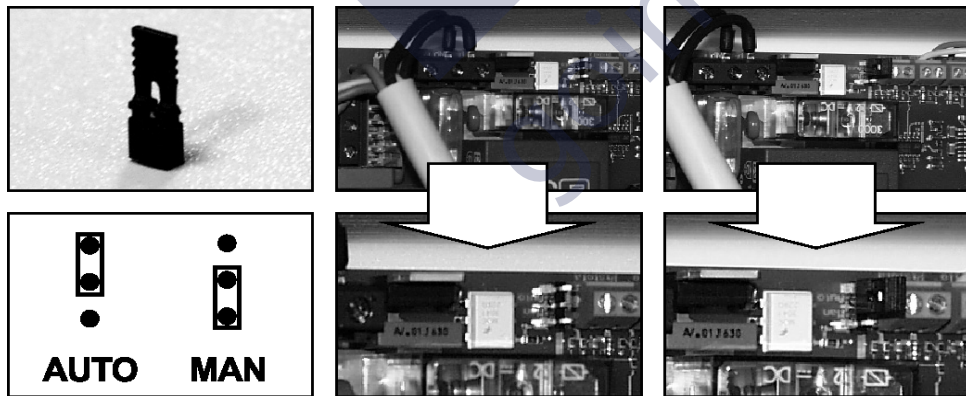

3.2 DISPLAYS

Two separate displays (LCD), with rear light, supply different information according to the operating MODE of MC.

NUMERIC DISPLAY (1 line, 4 numeric characters)

- In SYSTEM mode shows present time
- In DISPENSING mode shows dispensed quantity

ALPHANUMERIC DISPLAY (2 lines, 16 alphanumeric characters)

- In SYSTEM mode shows prompt messages and/or input data
- In DISPENSING mode shows measurement unit and user data



NUMERIC DISPLAY

ALPHANUMERIC DISPLAY

3.3 KEYPAD

The membrane keypad allows data to be entered. It includes:

- 10 alphanumeric keys
- the following "special" keys:



NUMBER to be used together with other keys for special functions;



STOP to stop the pump;

CANCEL

CANCEL to cancel digital data or to go back to a preceding stage;

ENTER

ENTER to confirm input data or options;



FS / FG to move within a menu and carry out the corresponding operations;



FD / FS to select suggested options (flashing)

3.4 ELECTRONIC KEYS AND KEY READER

MC controls access to the system by means of two different ELECTRONIC KEYS:

MASTER KEY is assigned to the manager. It is also used to transfer data to the PC. It is characterized by a RED handle.

Every user is assigned a USER KEY by the plant manager than can be used only for refuelling at the pump. There are two kinds of USER KEYS:

- a version with a green key holder having a four-digit code (key code) on the key-grip which is needed to identify the key at the time of user configuration;
- a version with a yellow key holder, without the four-digit code on the key-grip. This version has an internal identification code that is automatically recognized when the key is used.

The stations to be used with USER KEYS with YELLOW key holder indicate the software release of the station in the second line of the alphanumeric display (ex. ver. 3.0).

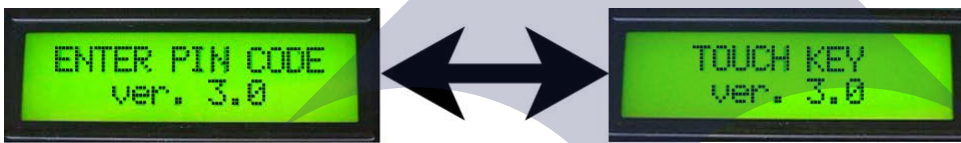

This message is displayed only when the station is waiting for pin code entry or key touch. It is never displayed in the menus or during dispensing.

The electronic keys are read by MC as soon as they are placed in the KEY READER on MC front.



4

HOW TO USE MC

4.1 GENERAL INFORMATION

Some information on the SOFTWARE installed in MC are necessary to use the unit and carry out all OPERATIONS required.

ATTENTION:

The MANAGER shall have a COMPLETE knowledge of the software, as he will probably make use of all available functions. Therefore we strongly recommend reading all paragraphs in this manual.

As for USERS, they can have partial knowledge, limited to the information necessary for dispensing operations.

4.1.1 GRAPHIC REPRESENTATION OF MC SOFTWARE

All ACTIVITIES offered by MC SOFTWARE are represented graphically by a FLOW CHART, showing what the LCDs visualize at the different operating stages.

Such indications (more frequently supplied by the alphanumeric LCD) are connected by arrows with a continuous line; near the lines the KEYS to be pressed are shown. Pressing the key results in reaching the following LCD indication, connected to the preceding one by the arrow.

In some cases the following stage is reached automatically, without pressing any key. This occurs when certain activities (of variable length – report printing, for example) have been completed. This case is represented by a dotted line with a clock at its side.

HOW TO USE THE KEYS

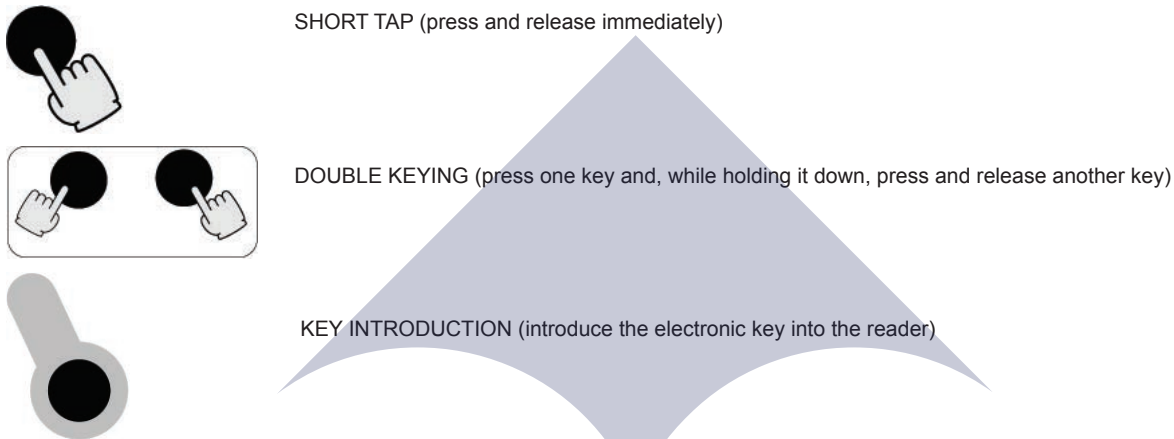

A MESSAGE DISPLAYED ON THE LCD

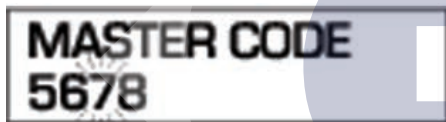

HOW MESSAGES ARE DISPLAYED ON THE LCD

FLASHING

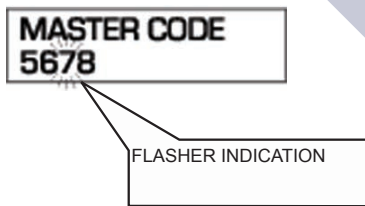

ALTERNATING FLASHING

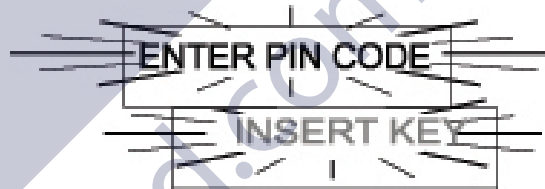

FLOW CHART

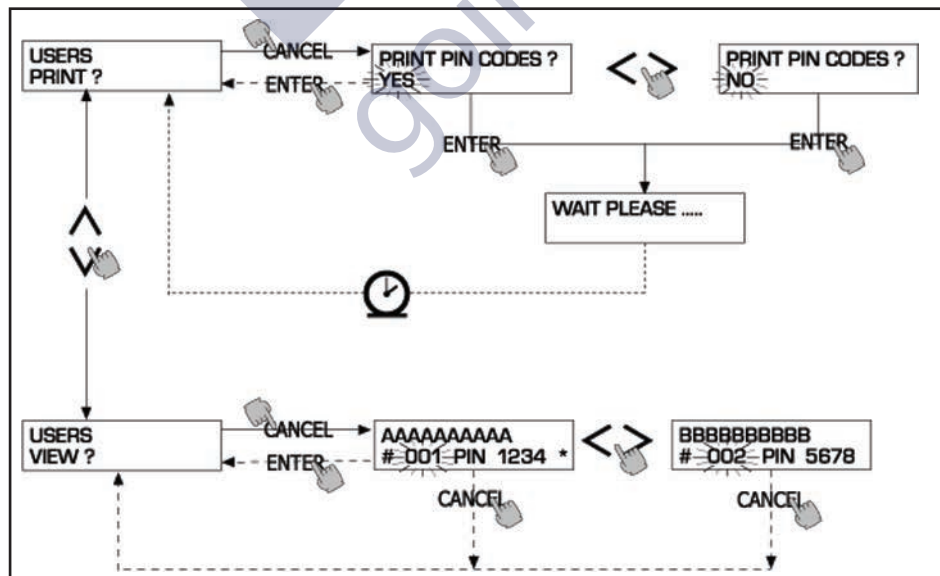

ATTENTION:**CANC KEY**

To simplify their graphic representation, some FLOW CHARTS do not show how CANC key is used, even if it is required for all activities.

Pressing CANC key always results in:

- going back to the previous view, OR
- cancelling a numeric input.

TIME OUT

In all activities and in all sections, failing to carry out any of the operations suggested (pressing a key, introducing the electronic key, dispensing) within a preset time (TIME OUT) results in exit from the activity concerned. In this way MC is not kept in input sections reserved to the manager for a long time, at the risk that non-authorized personnel has access to such activities. This kind of TIME OUT is not shown in the FLOW CHARTS.

4.1.2 SOFTWARE OVERVIEW

The activities that can be performed by MC SOFTWARE are divided into SECTIONS.

Each SECTION includes homogeneous operations.

Access to each SECTION can be automatic, free or protected by PIN CODE.

This SOFTWARE OVERVIEW shows the different available sections and offers a summary of the operations that can be carried out within each section.

SECTIONS:

BOOT

MC carries out a self-test on LCDs and displays MODEL and SERIAL NUMBER.

Access: - automatic, at start-up

Exit: - automatic, when operations have been completed.

ACCESS CONTROL

MC accepts entering a PIN CODE and checks if it is enabled.

Access: - by pressing a key

- by pressing STOP key

Exit: - automatic, after identification

- by pressing STOP

SYSTEM MANAGEMENT

Management operations are carried out (enabling users, report, calibration, transfer of data to PC).

Access: - from ACCESS CONTROL, recognizing a SYSTEM code

Exit: - when activities have been completed or after time out

SYSTEM CONFIGURATION

MC is adjusted to meet the requirements of a specific installation.

Access: - from SYSTEM in SYSTEM MANAGEMENT menu

Exit: - when activities have been completed or after time out

DISPENSING

Fuel is delivered.

Access: - from ACCESS CONTROL, by identifying an USER pin code

Exit: - when activities have been completed or after time out

Some sections perform activities without the operator's intervention (BOOT, ACCESS CONTROL).

Other sections (SYSTEM CONFIGURATION, DISPENSING) require the operator to supply input in sequence, as indicated by MC by means of prompts.

After all instructions/data have been entered, exit from the section is automatic.

Other more complex sections (SYSTEM MANAGEMENT) are organized in the form of MENUS.

The user (in this case the MANAGER only) selects such menus and the desired activity which, in turn, can be organized in SUBMENUS.

Each section is described in details in the following paragraphs.

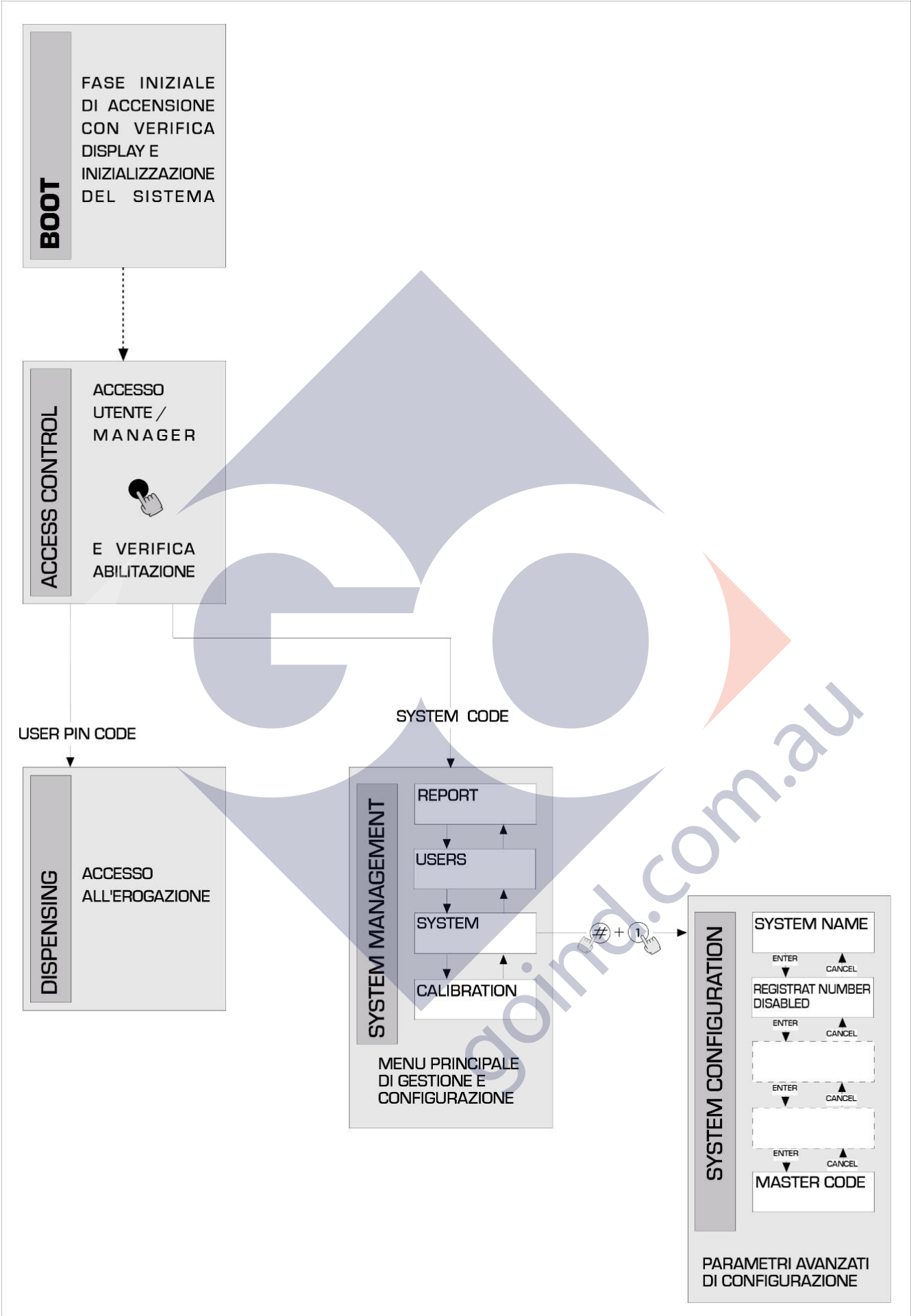

4.2 BOOT

BOOT is a section where TESTS are carried out by MC automatically.

This only occurs in the following cases:

- when MC is switched on by a general switch to be placed by the installer at SELF SERVICE supply side;
- when, without switching on/off the unit, the AUTO/MAN option is used to change from MAN to AUTO mode (see paragraph 3.1).

During BOOT it is possible:

- to check if the LCDs operate correctly (they are switched on completely and then off);
- to check MODEL;
- to check SERIAL NUMBER.

ATTENTION:

The SERIAL NUMBER displayed during BOOT is the S/N of the CPU board of MC.

The S/N is necessary to allow access to MC data in case the SYSTEM KEY has been lost and the MASTER PIN CODE has been forgotten. In this case take note of the station S/N and contact our SERVICE.

4.3 ALARM MANAGEMENT

Self Service MC offers the possibility of connecting an external LEVEL ALARM with the following feature: a contact is always open and it only closes on receiving an alarm signal.

This connection should be carried out to MC junction box directly, by replacing plug "Level alarm" (see diagram) with a fair lead PG7. When the alarm level is reached, MC reacts according to configuration.

- CONFIGURATION 1
LEVEL INPUT = NO / LEVEL OUTPUT = ALARM or LEVEL OUTPUT = PUMP CUTOUT

MC does not control level input and carries out no actions.

- CONFIGURATION 2
LEVEL INPUT = YES / LEVEL OUTPUT = ALARM

The remote printer (if any) prints the message "WARNING LOW LEVEL". Even after this action MC continues enabling fuel delivery. No message is displayed on the LCD.

- CONFIGURATION 3
LEVEL INPUT = YES / LEVEL OUTPUT = BLOCK

MC does not enable any further fuel deliveries. "DISPENSING IMPOSSIBLE / MINIMUM LEVEL" appears on the LCD.

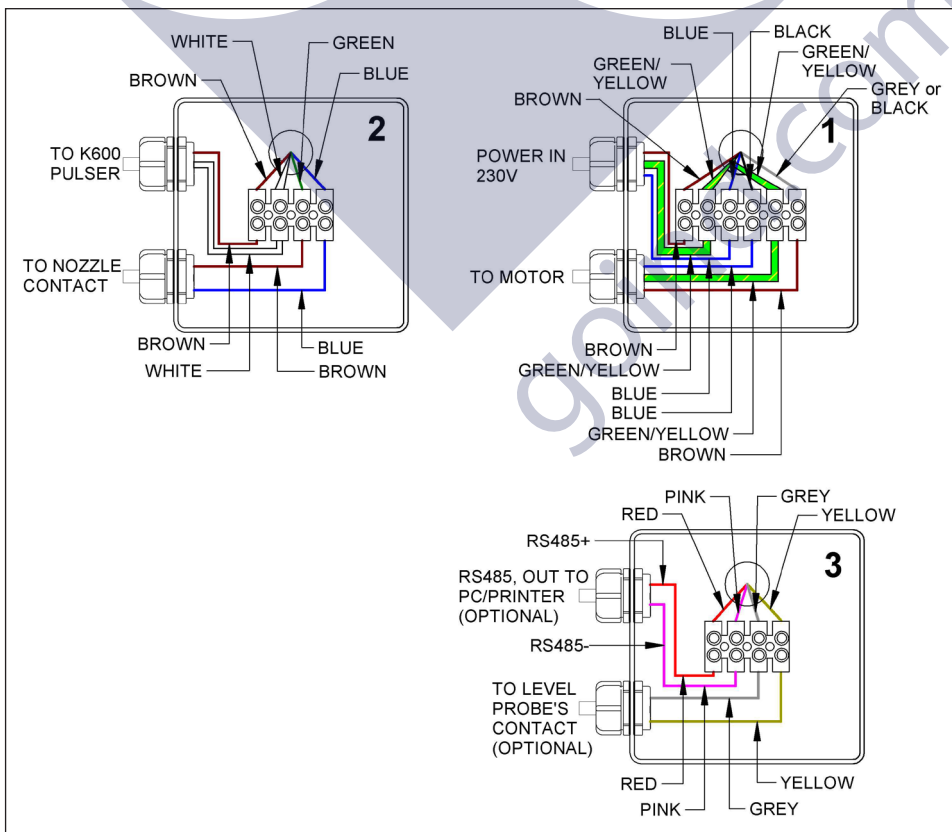

4.4 ACCESS CONTROL

The system changes to ACCESS CONTROL section as soon as one of the following event occurs:

a NUMERIC key is pressed to begin entering PIN CODE

MC checks if the PIN CODE entered has been enabled by the system and if it is associated with a USER or with the MANAGER. If the PIN CODE is not recognized as enabled, the message 'unknown code' is displayed.

If it is recognized as

- USER PIN CODE

MC reaches DISPENSING section.

- MASTER PIN CODE

MC reaches REPORT activity in SYSTEM MANAGEMENT menu.

4.5 SYSTEM CONFIGURATION

In the SYSTEM CONFIGURATION section the system is configured to meet the control requirements of a specific installation.

Only the Manager (or the installer) can have access to the SYSTEM CONFIGURATION section by means of the MASTER PIN CODE.

To have access to configuration act as follows:

- reach SYSTEM MANAGEMENT;

- select SYSTEM in the menu;

- press keys "#" + "1".

4.5.1 INSTALLATION CONFIGURATION

System configuration should be effected during installation.

First of all the installer shall define with the Manager which options (among the available ones) better meet the requirements of the installation concerned.

Configuration includes a series of OPERATIONS (selection or input) to be carried out in succession.

A DEFAULT value is available for each operation: it can be modified or confirmed by pressing ENTER (in this way the following operation is reached).

A detailed explanation of each operation is supplied here below.

Paragraph titles correspond exactly to the words displayed for each specific operation.

UNIT NAME

The Manager can decide to give a name to the station.

When entered, the name will appear on the tickets.

It is possible to enter no name.

DEFAULT value: none

Allowed values: ALPHANUMERIC string, max 16 characters

REGISTRATION NUMBER

This operation determines if the user will or won't be asked to enter an identification name (or number) for the vehicle to be supplied with fuel.

If the request for identification is selected, the user shall enter a value to carry out the delivery (any value is accepted by the system).

DEFAULT value: DISABLED

Allowed values: DISABLED (not requested)
ENABLED (requested)

ODOMETER (Odometer value)

This operation determines if the user will be or won't be asked to enter the odometer value of the vehicle to be supplied.

If the request for odometer value is selected, the user shall enter a value to carry out the delivery (any value is accepted by the system).

DEFAULT value: DISABLED

Allowed values: DISABLED (not requested)
ENABLED (requested)

START TIME OUT

This operation defines how much time is available for the user to start dispensing fuel, starting from the moment when the pump is enabled by the system. If no dispensing is started within such time, MC disables the pump. To carry out delivery, the user will have to repeat the identification procedure (enter pin code).

DEFAULT value: 60 sec

Allowed values: from 001 to 999 sec.

FILLING TIME OUT

This operation defines how long a delivery can be interrupted. After being started, delivery can be stopped momentarily by the user or automatically by the automatic nozzle.

When this break (with pump on but no metering in course) is longer than the set time, the pump is disabled and stops. To resume dispensing the user will be asked again for identification (pin code or key) and a new delivery will start.

If the nozzle is put back in its seat during the "filling time out", delivery is stopped definitely (pump deactivated).

DEFAULT value: 120 sec.

Allowed values: from 001 to 999 sec.

REMOTE PRINTER

This operation defines if a remote printer will be connected to SELF SERVICE by serial line RS 485. The printer can be placed in an office even hundreds of meter far from the station; it will be used to issue tickets, to log deliveries or to print reports on manager's request.

ATTENTION:

The printer must be equipped with:

- serial port RS 485
- serial port RS 232 + converter RS 232/485 (available on request) parallel port centronics + converter RS 232/485 + converter RS 232 / Centronics (available on request)

DEFAULT value: NO

Allowed values: YES (Connected Printer)
NO (Not Connected Printer)

Setting remote serial printer:

Protocol: 8 - N - 1

BAUD RATE: 2400

Word Length: 8 bit

Parity: None

Bit Stop: 1

The following activities will be displayed only if YES (Connected Printer) is selected:

REMOTE PRINTER / TYPE

This operation defines if SELF SERVICE MC will be connected to:

- a remote 80-column printer (standard office printer)
- a remote 40-column printer (printer with paper roll to issue tickets)

DEFAULT value: 80 COLUMNS

Allowed values: 80 COLUMNS (80-column Printer)
40 COLUMNS (40-column Printer)

REMOTE PRINTER / PRINT OUT

This operation defines if the remote printer will print

- tickets (exact copies of the tickets printed by the internal printer at SELF SERVICE station);
- a report line for each delivery ("logging" activity)

DEFAULT value: LOGGING

Allowed values: LOGGING
TICKET

REMOTE PRINTER / AUTO CR-LF (line feed)

Thanks to this operation, commands sent by SELF SERVICE MC to the printer are adjusted to printer type. The printer may require a line feed command.

ATTENTION:

We recommend leaving the DEFAULT value unchanged for the first printing attempts; in case of problems in returning to configuration mode and modifying the parameter.

DEFAULT value: NO

Allowed values: NO ("line feed" Command not Sent)
YES ("line feed" Command Sent)

REMOTE PRINTER / LINE DELAY

Should the printer not be provided with a temporary memory large enough to handle queues of printing data, it is possible to change the delay time of data transmission to the printer, so that queue handling is facilitated and data is not lost.

ATTENTION:

We recommend leaving the DEFAULT value unchanged for the first printing attempts; should the printer not receive all data, return to configuration mode again and modify the parameter.

DEFAULT value: 100 x 10 ms

Allowed values: 100-999 x 10 ms

The following activity will be displayed only if NO is selected in REMOTE PRINTER operations (NO = Non Connected Printer):

PC CONNECTED

This operation defines if a PC with software SELF SERVICE will be connected to SELF SERVICE by means of a serial line RS 485. Thanks to this software delivery data can be collected and managed. (see manual M0090).

MEASUREMENT UNIT

This operation defines which unit of measurement the system will use.

DEFAULT value: LITRES

Allowed values: LITRES
US GALLONS

DECIMAL DIGIT

This operation defines the number of decimals by which the quantity supplied will be displayed.

If 2 decimals are selected, when the displayed value exceeds 99.99 the system automatically displays one decimal only.

DEFAULT value: 1

Allowed values: 1-2

LOW LEVEL INPUT = YES / NO

This activity defines the use of optional level contact (see paragraph 4.3).

YES = level input is controlled; NO = level input is not controlled.

LOW LEVEL INPUT = ALARM / PUMP CUT OUT

This option will be displayed only if YES has been selected for LOW LEVEL INPUT (see paragraph 4.3). It defines which electronic response will be given when the level alarm contact closes.

ALARM = the remote printer (if any) prints a message.

"PUMP CUT OUT" = MC stops the pump and does not enable any further dispensing.

KEY READER

This operation defines if the key reader (placed on MC front) is enabled or not.

DEFAULT value: YES

Allowed values: YES (Enabled Reader)

NO (Disabled Reader)

MASTER CODE (Manager's pin code)

Thanks to this activity the MASTER CODE (DEFAULT value: "1234") can be modified.

When in MASTER CODE the system displays the code valid at present:

- press "ENTER" to confirm it and go to the following activity;
- press a numeric key to modify the code.

ATTENTION:

The new code must consist of 4 figures.

After typing, confirm the new code by pressing ENTER; MC will display the OLD PIN and the NEW PIN:

- *press "ENTER" to confirm modification of Manager's pin code;*
- *press "CANCEL" to cancel the operation and confirm the OLD code.*

MASTER KEY (Replacing Manager's key)

This activity allows the MASTER KEY to be replaced with a new one.

When MASTER KEY is displayed, it is possible:

- to exit from SYSTEM CONFIGURATION by pressing "CANCEL"; in this way the same key as before is kept (no change in MASTER KEY);
- to introduce a new KEY in the key reader to enable it as MASTER KEY and replace the old one.

ATTENTION

There can be just one MASTER KEY at a time enabled for a CUBE MC station. However it is possible to have the same MASTER KEY enabled for different stations.

4.5.2 CHANGING CONFIGURATION

Should any selection made during first configuration be modified, operate as follows:

- reach CONFIGURATION section;
- press "ENTER" to confirm the selections to be left UNCHANGED until the selection to be changed is reached;
- press "ENTER" to confirm the remaining selections (to be left unchanged) down to the last activity
- exit from CONFIGURATION by pressing "CANCEL"

SYSTEM CONFIGURATION

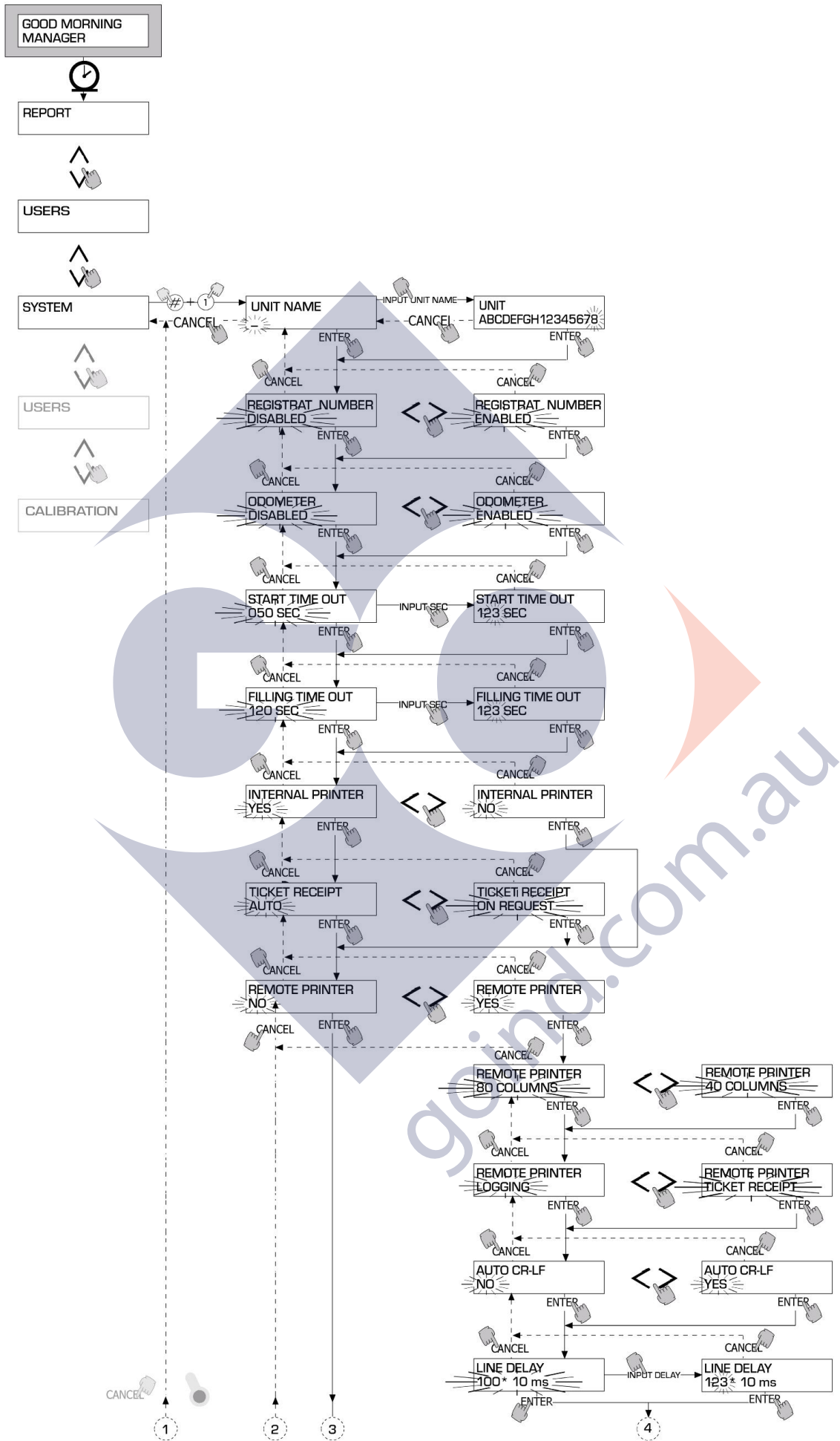

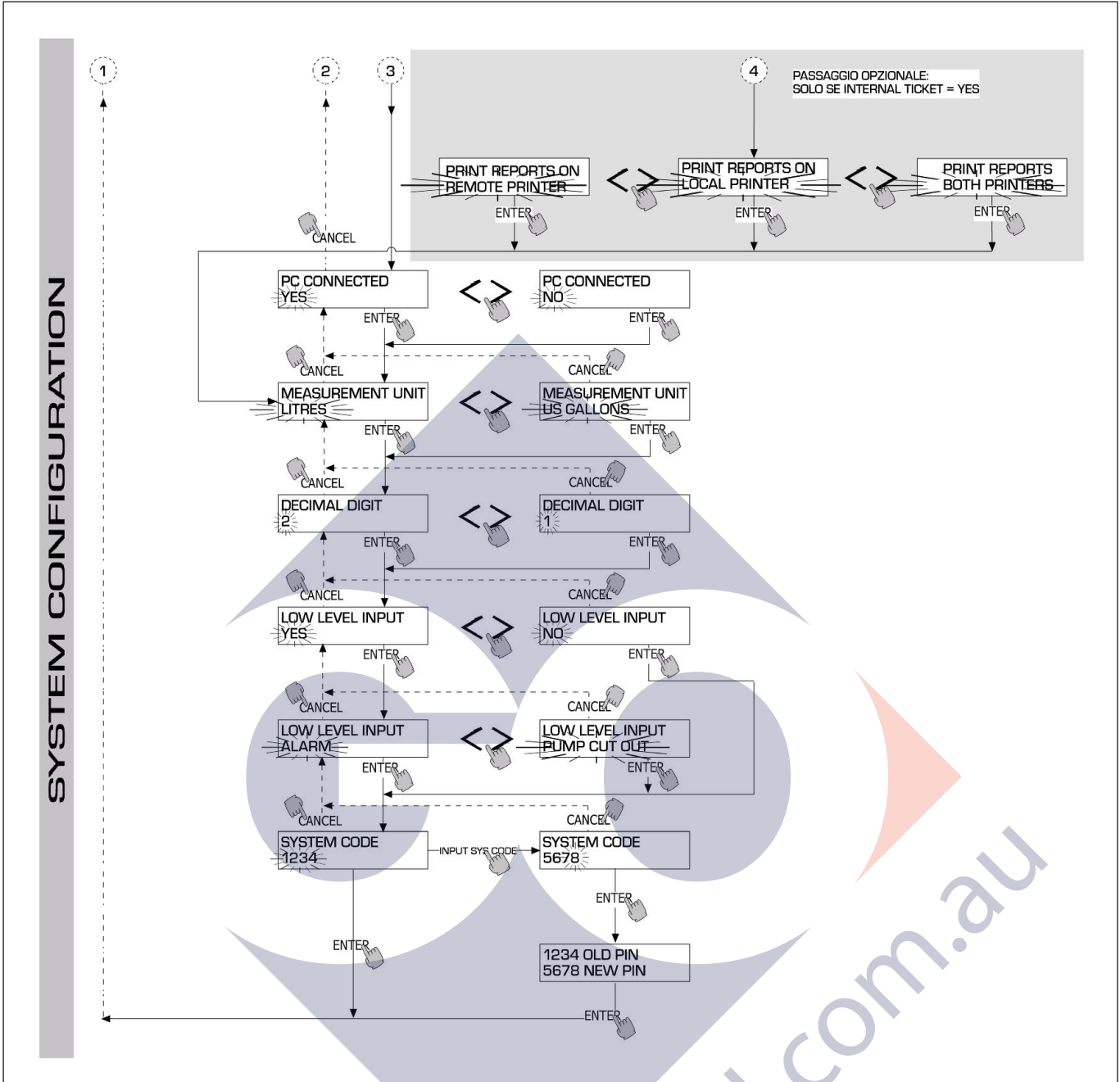

4.6 SYSTEM MANAGEMENT

SYSTEM MANAGEMENT section allows the Manager to control MC system daily. SYSTEM MANAGEMENT is divided into menus and submenus to offer an easy and quick access to the activities. The main menu includes the following six activities:

4.6.1 REPORT

Three different printing types are available for the remote printer (if any). Operate as shown in the following FLOW CHART.

4.6.1.1 REPORT / TRANSACTION

Thanks to this activity all fuel deliveries (TRANSACTIONS) stored in MC memory can be printed.

ATTENTION:

Data in MC memory can be transferred to a PC (equipped with specially-supplied software) by means of a serial line. Fuel deliveries can be printed only if they have not been transferred yet, as transfer causes data to be cancelled from station memory.

Printing of deliveries can be:

- complete, that is covering all deliveries stored in memory (select: ALL DATES + ALL USERS);
- limited to a time period falling between two dates (select: PERIOD);
- limited to a single date: (select: PERIOD and enter the same date twice);
- limited to a single user (select: SINGLE USER) identified by the corresponding USER NUMBER (progressive number between 1 – 80, attributed to each user).

Above limitations can be applied simultaneously. Example: printing of deliveries carried out by an individual user in a certain period of time.

SELF SERVICE	MC	08:40:56	28-03-03
TRANSACTION LIST			
DATE : 28/03/03			
TIME	USER	QUANTITY	ODOMETER REG. NUM
		(LITER)	
08:24	001	6.26	
08:37	005	4.09	
08:37	001	4.16	
08:38	001	3.11	
08:38	002	5.97	
08:38	004	2.92	
08:39	005	1.06	
08:39	003	3.06	
08:39	002	1.06	

goind.com.au

4.6.1.2 REPORT / USERS

This operation is used to print a list of enabled users.

Two possibilities are available:

PRINT CODE > YES

A list complete with PIN CODE of each user is printed.

PRINT CODE > NO

A list without PIN CODE of each user is printed.

ATTENTION:

Obviously PIN CODE printouts shall be kept secret to prevent PIN CODES from being divulged.

Following data are printed for each user:

- progressive USER NUMBER,
- USER NAME,
- PIN CODE.

SELF SERVICE MC			08:40:46 28-03-03	
USERS LIST				
NUMBER	NAME			
001	MARIO			
002	JOHN			
003	PAOLO			
004	ROSSI			
005	SMITH			
006	HENRY			

Print code - no

SELF SERVICE MC			08:40:46 28-03-03	
USERS LIST				
NUMBER	NAME			CODE
001	MARIO			0001
002	JOHN			0002
003	PAOLO			0003
004	ROSSI			0004
005	SMITH			0005
006	HENRY			0006

Print code - yes

4.6.1.3 REPORT / CONFIGURATION

Options selected in configuration section can be printed as follows:

explanation of each parameter can be found in paragraph 4.5.1

SELF SERVICE FM		08:40:23 28-03-03	
UNIT CONFIGURATION			
REG. NUMBER		DISABLED	
ODOMETER		DISABLED	
START TIME OUT		050 sec	
FILLING TIME OUT		120 sec	
INTERNAL PRINTER		YES	
TICKET RECEIPT		AUTO	
REMOTE PRINTER		YES	
TYPE		40 COLUMNS	
PRINT OUT		TICKET REC	
AUTO CR-LF		NO	
LINE DELAY		10 *10 mSec	
PRINT REPORT ON		BOTH PRINTERS	
PC CONNECTION		NO	
DISPENSING UNIT		LITERS	
DECIMAL DIGIT		2	
LOW LEVEL INPUT		ALARM	
KEY READER		YES	
OC10 PRESENT		YES	

4.6.1.4 REPORT / TOTALS

This operation is used to print the GENERAL TOTAL, the TOTAL FROM XX/XX/XX and the USER's TOTAL.

GENERAL TOTAL: total quantity dispensed starting from Self Service first installation. It can't be by any means reset by the manager.

TOTAL FROM XX/XX/XX: total quantity dispensed since last reset. It corresponds to the sum of all "User's totals". It can be reset by the manager.

USER's TOTAL: total quantity dispensed to an individual user since last reset (that is starting from "TOTAL FROM..." date). The manager can reset all USER's totals simultaneously by resetting "TOTAL FROM"; an individual USER's TOTAL can not be reset.

Following submenus allow totals to be displayed, printed and reset:

- * TOTALS VIEW? to display totals (GENERAL TOTAL, TOTAL FROM and USER's TOTAL);
- * TOTALS PRINT? to print totals (GENERAL TOTAL, TOTAL FROM and USER's TOTAL);
- * TOTALS RESET PERIOD? to reset TOTAL FROM, and consequently all USER's TOTALS.

SELF SERVICE 16:13:53 01-12-03

General Total : 383 LITERS
 Total : 83 LITERS
 From : 01/12/03
 User ID : Name : Total :
 : : (LITERS) :

User ID	Name	Total (LITERS)
001	MARIO	19
002	JOHN	16
003	PAOLO	19
004	ROSSI	21
005	SMITH	0
006	HENRY	8

TOTALS -> PRINT -> ALL

SELF SERVICE 16:14:26 01-12-03

General Total : 383 LITERS
 Total : 83 LITERS
 From : 01/12/03

TOTALS -> PRINT -> ONLY GENERAL

SELF SERVICE 16:14:47 01-12-03

From : 01/12/03
 User ID : Name : Total :
 : : (LITERS) :

User ID	Name	Total (LITERS)
001	MARIO	19

TOTALS -> PRINT -> SINGLE USER

goind.com.au

REPORTS

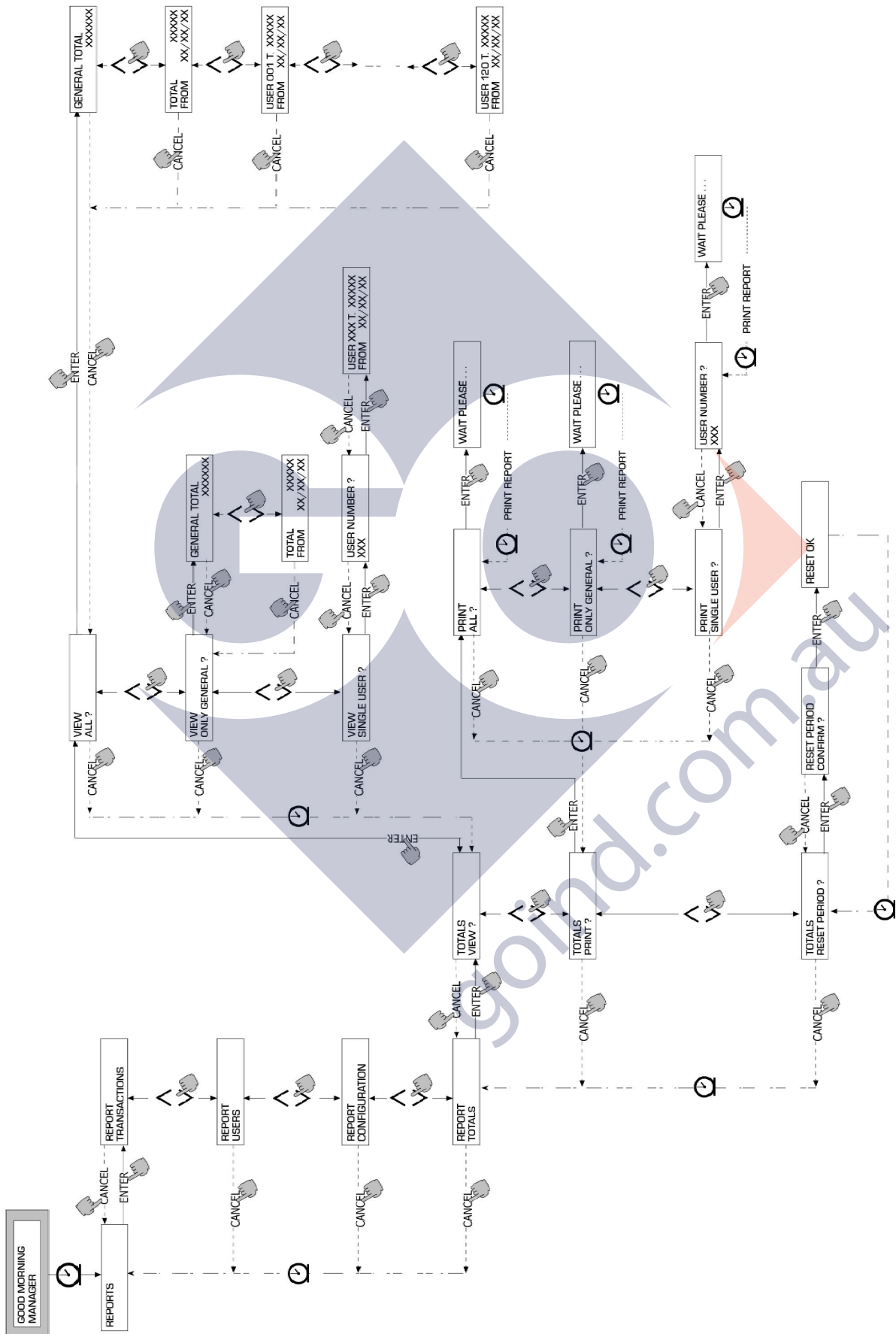

4.6.2 USERS

Control of SELF SERVICE users is possible thanks to 4 different activities, included in a submenu.

ATTENTION:
When no user is enabled, only USER/ADD activity (4.6.2.1) is displayed.

4.6.2.1 USERS / ADD

A new enabled user can be added (ADD) as shown in the following flow chart.

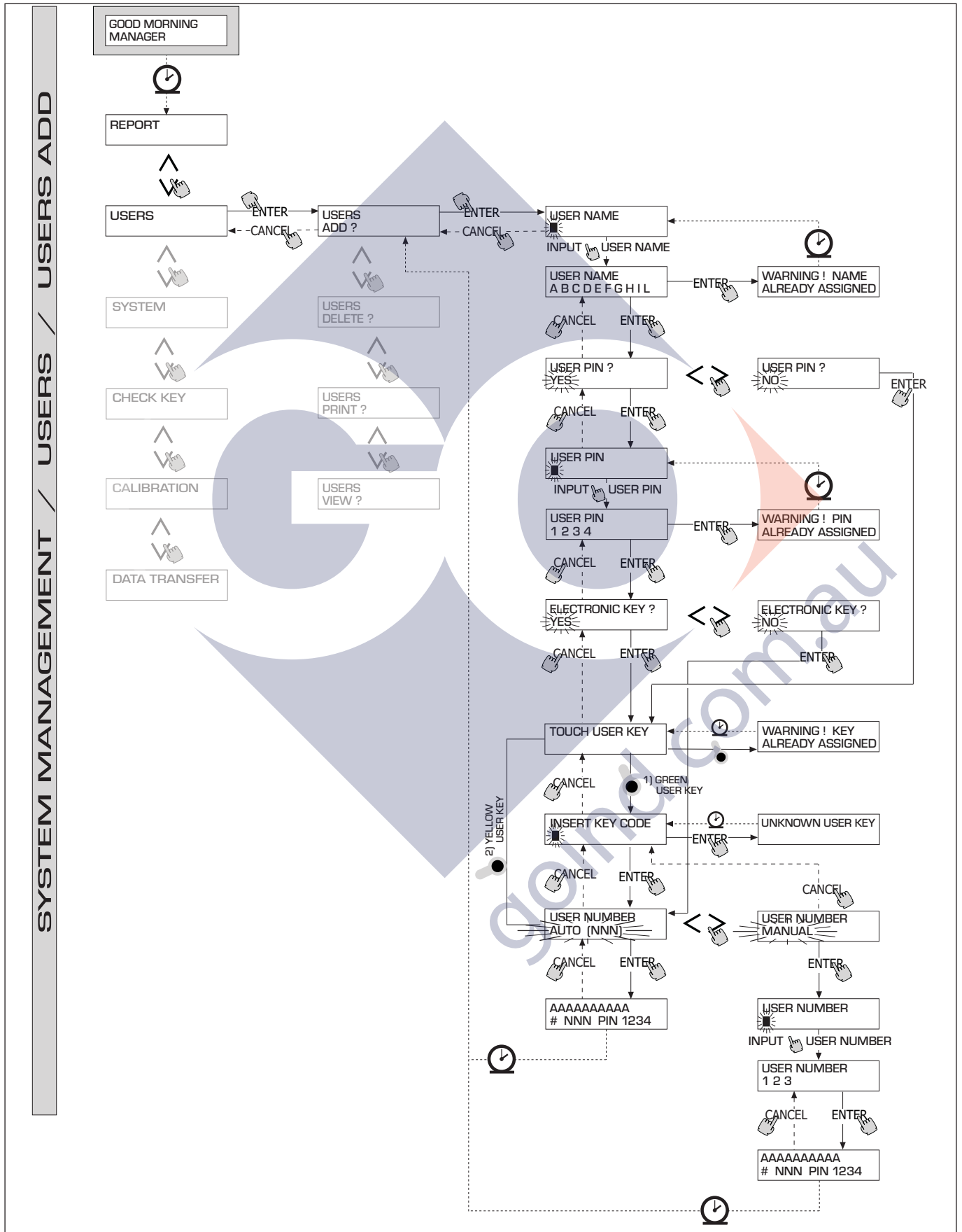

USER NAME

This free alphanumeric field consists of 1 - 10 characters; this input can not be omitted.

USER PIN

It is the personal pin code assigned to each user.

The following is displayed: USER PIN > YES / NO.

If USER PIN > NO is selected, the user is given no pin code but only an electronic key. The system asks directly for key introduction (following paragraph).

If USER PIN > YES is selected, the personal user pin code shall be typed (a numeric field including 1 -4 figures).

ATTENTION:

When a user pin code is assigned all 4 figures should be typed. As a consequence, if "4" has to be entered as user pin code, you must type "0004". At dispensing stage, however, the user is only required to type "4" and press "ENTER". Should a USER PIN be entered which has already been assigned to another user, MC identifies it, does not accept it and asks for another code.

ELECTRONIC KEY

The following is displayed: ELECTRONIC KEY > YES / NO.

If ELECTRONIC KEY > YES is selected, the system displays TOUCH USER KEY to ask for the key to be introduced into the reader. In this way the key is assigned to that particular user.

The system exits from this section only when a key is introduced into the reader and is identified thanks to a four-figure code applied on same.

Should a key be used which has already been assigned to another user enabled for that station, MC does not accept assigning it to the new user and displays "WARNING KEY ALREADY ASSIGNED".

ATTENTION:

Be sure that you are assigning a USER KEY (green).

KEY CODE

The KEY CODE is a 4-figure code applied on the handle of the USER KEY, allowing it to be identified by the station. It is only used at user configuration stage; for this reason it is not necessary for the final user's daily operations. Should the key code be lost or damaged, a new configuration of the user key is not possible; on the contrary, if the key has already been configured it can be regularly used.

ATTENTION:

The key code is required only on models which are provided with Green User Keys. No code is required on models which are provided with Yellow User Keys.

USER NUMBER

It is a progressive number – between 1 and 80 – assigned to each user.

ATTENTION:

Unlike the PIN CODE, the USER NUMBER can be freely divulged because it is simply a number associated with user name to make some activities easier for the Manager example: (printing deliveries).

The following is displayed: USER NUMBER > AUTO (NNN) / MANUAL.

If USER NUMBER > AUTO (NNN) is selected, the user is automatically assigned the number displayed (NNN), corresponding to the lowest user number available (= not yet assigned).

If USER NUMBER > MANUAL is selected, the manager is free to assign any USER NUMBER (not yet assigned).

Should a USER NUMBER be entered which has already been assigned to another user, MC identifies it, does not accept it and asks for another number.

Both in the case of automatic and manual selection, as soon as confirmation is given by pressing "ENTER" the system displays all data concerning the user for some seconds; then it returns to menu USER / ADD.

ATTENTION

The system does not accept any partial modification of user data. If user data entered and confirmed are wrong, act as follows:

- delete user (see paragraph. 4.6.2.2);
- enter user correctly.

4.6.2.2 USERS / DELETE

An enabled user can be deleted as shown in the following flow chart.

To select the user to be deleted, enter his USER NUMBER.

The system displays all data concerning the user selected and asks for confirmation of delete operation.

ATTENTION

Deletion is definitive and the only way to have the user restored is to repeat user/add procedures.

When a user is deleted:

- he can no longer have access to fuel dispensing by means of his PIN CODE or USER KEY;
- his USER NUMBER is free;
- his electronic key can be assigned to another user.

4.6.2.3 USERS / PRINT

The remote printer can print a list of enabled users (see flow chart).

4.6.2.4 USERS / VIEW

Thanks to this operation all enabled users can be displayed (see flow chart).
Following data are visualized for each user:

- progressive USER NUMBER,
- USER NAME,
- PIN CODE.

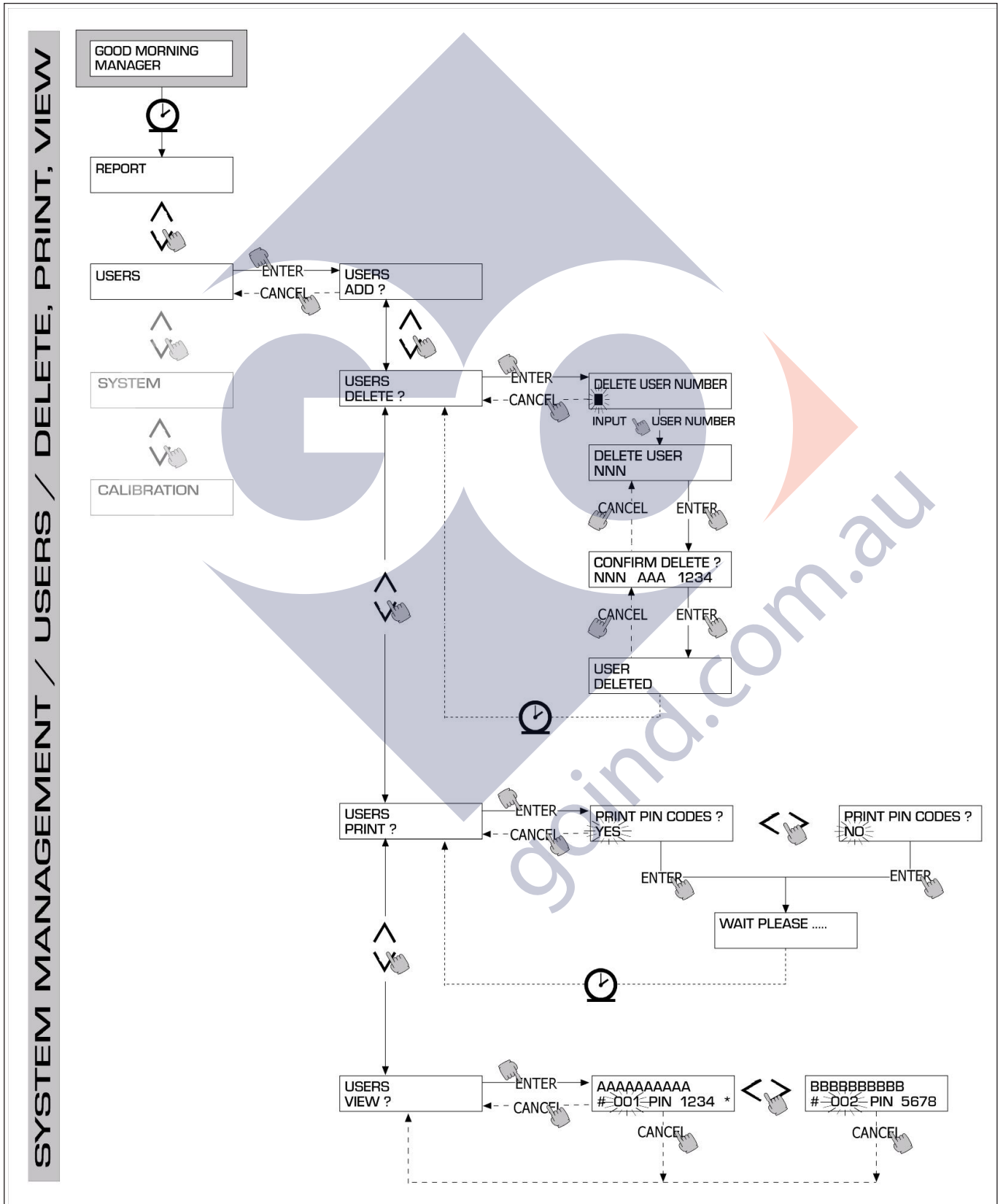
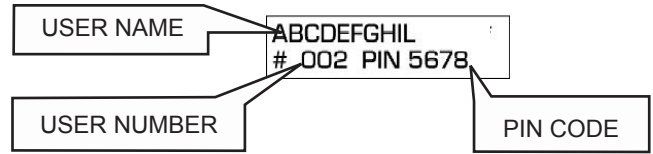

4.6.3 SYSTEM

This activity gives access to SYSTEM CONFIGURATION (typical procedures belonging to first installation) described in paragraph 4.5, as well as to a submenu which includes the 4 activities shown in the following flow chart.

4.6.3.1 SYSTEM / SERIAL NUMBER

The SERIAL NUMBER of the electronic board of MC system is visualized.

ATTENTION:

The SERIAL NUMBER of the electronic board does NOT CORRESPOND o the serial number of the station shown on DATA PLATE placed on the unit.

There is an additional method to have the S/N visualised WITHOUT using the MASTER CODE:

- Turn the station off and on by means of the general switch; when in BOOT section the system displays the S/N for some seconds.

4.6.3.2 SYSTEM / MEMORY

This activity gives access to an additional submenu allowing the following activities:

- **SYSTEM / MEMORY / VIEW**

This activity shows how much space is occupied in memory: occupied positions are compared with max. available positions (= 255).

Occupied positions are made free when data stored in MC memory are transferred to the PC through RS. This operation takes place automatically at short intervals (just a few seconds) provided that SELF SERVICE MANAGEMENT program has been started on the PC.

ATTENTION

Printing delivery data (both by local and remote printers) is not regarded as “transfer of data”; as a result it does not make memory positions available.

If this operation is not carried out, memory can become completely saturated (USED MEMORY 255/255). In this case MC does not enable any further delivery and the LCD of the station displays “FULL MEMORY”.

Manager's action is required. He can:

- connect MC to a PC through RS 485;
- clean memory by means of “MEMORY RESET”.

• **SYSTEM / MEMORY / RESET**

Thanks to this operation, occupied memory can be made available for data from additional deliveries.

This activity can be carried when memory is totally or partially occupied.

ATTENTION

After a “MEMORY RESET” the Manager won't be able to print or transfer cancelled data any more. Therefore “MEMORY RESET” should be used as an exception and, if possible, after printing all deliveries that are going to be cancelled. Cancellation is irreversible.

4.6.3.3 SYSTEM / DATA / TIME

Thank to this operation, present date and time (to be recorded during dispensing) are set.

ATTENTION

The system is equipped with a perpetual calendar which changes year on dates automatically, keeping leap years into consideration. The calendar does NOT change from solar to summer time automatically.

4.6.3.4 SYSTEM / BUZZER

This operation defines if a buzz shall be emitted every time a key is pressed.

4.6.4 CHECK KEY

The Manager (only) can check if a key is enabled for a particular MC station and he can identify the user associated with that key.

When MC displays the message “TOUCH KEY”, just introduce the key into the reader to have it identified immediately.

If the key is a “MASTER KEY” the LCD displays:

- “UNKNOWN MASTER KEY” if it is not enabled for the station concerned;
- “MASTER KEY” if it is enabled for the station concerned.

ATTENTION

Remember that there is one “MASTER KEY” only for each station. It is impossible to have two keys enabled as “MASTER KEYS” for the same station. On the contrary, the same master key can be enabled as “MASTER KEY” for different stations.

If the key is a “USER KEY” the LCD displays:

- “UNKNOWN USER KEY” if it NOT enabled for station (i.e. it has not been associated with any users);

user's data as follows, if the key has been enabled for the station concerned.

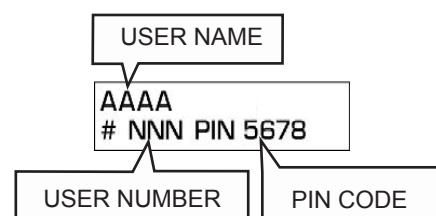

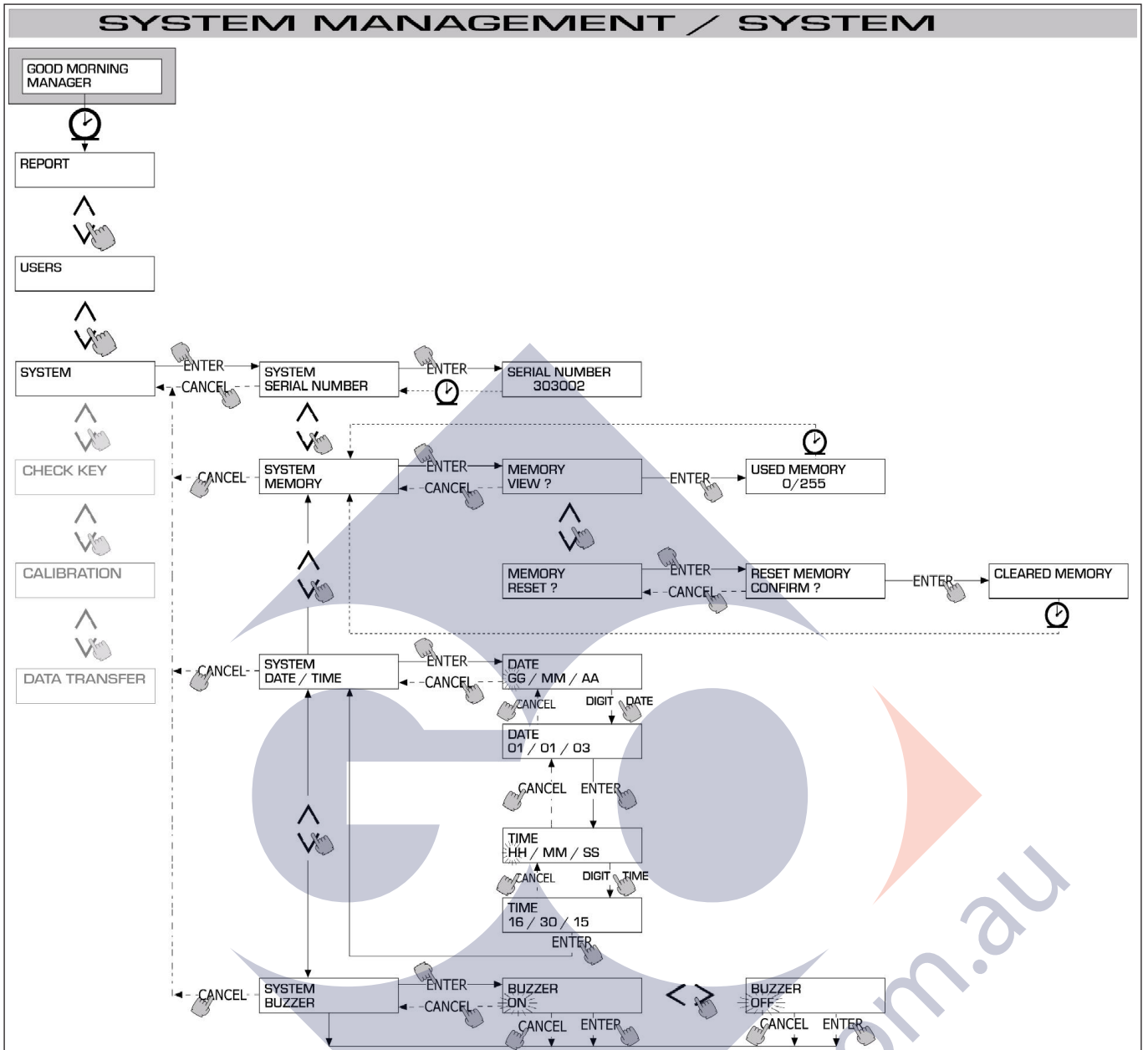

4.6.5 CALIBRATION

Calibration offers a submenu where the two following activities can be selected to check or modify CALIBRATION of FUEL-METER/PULSER K600.

4.6.5.1 CALIBRATION VIEW

The CALIBRATION FACTOR being used is displayed.

All fuel-meters/pulsers K600 installed on the stations are pre-set by the factory for use with FUEL OIL; the calibration factor displayed will be "K FAC 1.0000".

After carrying out a calibration, K FAC will be different from 1.0000.

ATTENTION:

This activity is performed to optimize fuel-meter accuracy. After calibration, K FAC will be different from 1.0000 by ± 5% max, that is it shall fall within the 0.9500 - 1.0500 range. Larger differences may result from incorrect calibration procedure.

4.6.5.2 CALIBRATION / MODIFY

This activity offers an additional submenu where two different calibration procedures are available. They are:

- CALIBRATION / DIRECT

Calibration/DIRECT allows the calibration factor (K FACTOR) to be modified directly.

This calibration mode can be used when the calibration factor is to be modified by a known percentage, to correct an average mistake on the basis of one or more deliveries.

ATTENTION:

The new K FACT should always be calculated on the basis of the K FACT being used at present.

Example: if the present calibration factor is 1.0120 (value obtained by a previous calibration, as it is different from the factory-set initial value 1.0000) and:

- *the fuel-meter counts a value which is on the average 1,5 % higher than the actual one, the new K FACT, capable of correcting the average mistake, will be calculated as follows:*

$$\text{new K FACT} = 1.0120 * (1 - (1,5/100)) = 0.9968;$$

- *the fuel-meter counts a value which is on the average 0,8 % lower than the actual one, the new K FACT, capable of correcting the average mistake, will be calculated as follows:*

$$\text{new K FACT} = 1.0120 * (1 + (0,8/100)) = 1.0200.$$

- CALIBRATION / BY DISPENSING

Calibration BY DISPENSING takes place by dispensing fuel in a SAMPLE CONTAINER.

Calibration BY DISPENSING is quick and easy and does not require the operator to make any calculations.

Calibration dispensing can be interrupted when desired and is stopped when fuel level reaches the graduated area in the sample container. Press "ENTER" to confirm that calibration by dispensing has been completed.

ATTENTION:

To achieve a good calibration of the fuel-meter use a precise container with capacity > 20 litres.

In addition operate as follows:

- *remove air from pump, pipes and fuel-meter by dispensing fuel until a full regular flow is obtained;*

- *stop the flow by closing the nozzle without switching off the pump;*

- *do not reduce the flow rate to reach the graduated area of the container.*

A correct technique requires the flow to be stopped and released at a steady rate until the desired level is reached.

Keep number of interruptions as low as possible.

Should SELF SERVICE display a value different from the one indicated by the container (ACTUAL VALUE), the value displayed by SELF SERVICE shall be corrected to have it coincide with the ACTUAL VALUE.

As soon as the correction is confirmed by pressing "ENTER", the system will calculate the new calibration factor (K factor) and display it for some seconds.

From now on the system will use the new calibration factor.

ATTENTION:

One delivery is enough to obtain the definitive calibration of the fuel-meter. After calibration check if fuel-meter accuracy falls within acceptable limits. To check fuel-meter accuracy dispense fuel by using a User pin code (and not the Master pin code).

SYSTEM MANAGEMENT / CALIBRATION

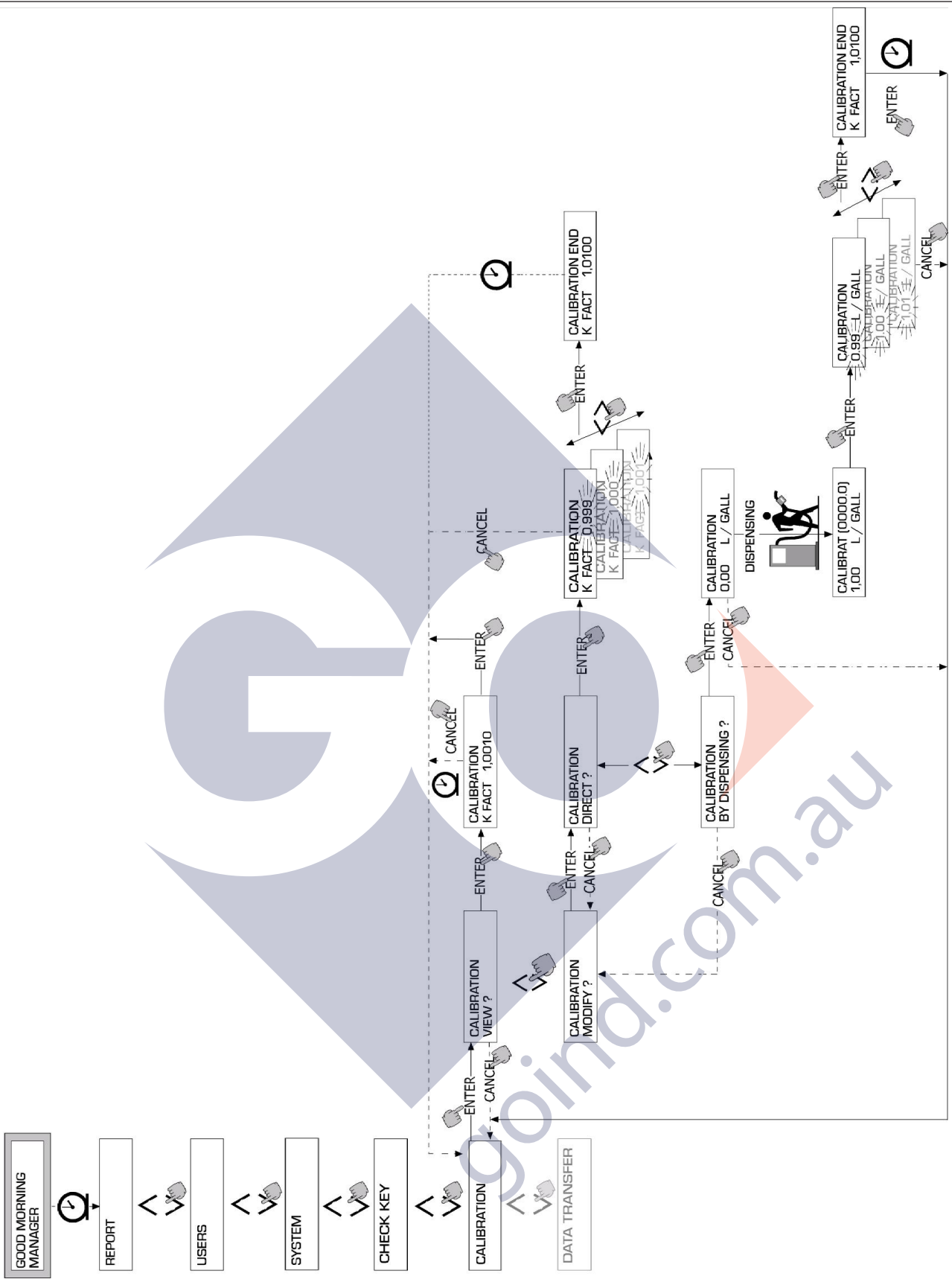

4.6.6 DATA TRANSFER

Thanks to this operation delivery data is transferred from station memory to the electronic MASTER KEY. In this way such data can be transferred to the memory of a PC equipped with KEY READER, where the program "software SELF SERVICE" has been installed.

ATTENTION:

Program installation and data transfer procedures can be found in manual M0090.

As soon as the key is introduced into the reader the system identifies it and displays one of the following messages:

- UNKNOWN MASTER KEY

This means that the key is a USER KEY or a MASTER KEY not enabled for the station concerned.

- KEEP IN PLACE / WAIT

This message is displayed when ALL the following conditions are fulfilled:

- the key is the MASTER key of the station;
- the station has stored data which has not been transferred yet;
- the key is "EMPTY", which means that data collected previously has been already transferred to the PC.

ATTENTION:

The MASTER key is "EMPTY" when it has NO DELIVERY stored in memory. The MASTER key is "FULL" (message FULL SYSTEM KEY) even when it has JUST ONE delivery stored in memory. When a key is loaded with ANY number of deliveries between 1 and 255, it changes from EMPTY to FULL and no additional deliveries can be transferred to it. To transfer additional data to the PC by using the same key, act as follows:

- *unload stored data on the PC, thus restoring the "EMPTY" key condition;*
- *transfer additional data from the station to the key;*
- *unload the key on the PC.*

The same key can be enabled as MASTER KEY for different stations; however, for the reason described above, data transfer to the PC will only be possible for ONE STATION AT A TIME.

When data transfer from station to key has been completed, the system displays OK (= positive result) or FAILED (= negative result) for a short time.

Key condition changes to "FULL" (FULL MEMORY KEY) only in case of successful transfer (OK), otherwise the key is still "EMPTY" and transfer from station to key can be repeated.

ATTENTION:

Data transfer from station to key can last from less than one second to several seconds, depending on the number of deliveries to be transferred. To ensure a successful transfer keep the key against the reader until the message "OK" is displayed. If the key is moved, transfer can not be completed correctly.

- FULL MASTER KEY

This message is displayed when the key is "FULL" and it should be unloaded on the PC.

Two cases are possible:

- 1) Station memory is NOT FULL: less than 255 deliveries are stored. In this case, even if memory can not be unloaded, further deliveries are possible up to 250 max.
- 2) Station memory is FULL: 255 deliveries are stored and have NOT been TRANSFERRED YET. In this case, if station memory can not be unloaded, no further dispensing is possible. Following message is displayed: "CONFIRM M. KEY / OVERWRITE?".

If the answer is yes, press ENTER to allow the new 255 delivery data to be overwritten on the data stored in key memory (and not yet transferred to the PC).

ATTENTION:

Overwritten data will be definitely lost, but the station will be enabled to dispense fuel immediately.

- MEMORY EMPTY

This message informs that the station has no data to be transferred. Its memory is empty.

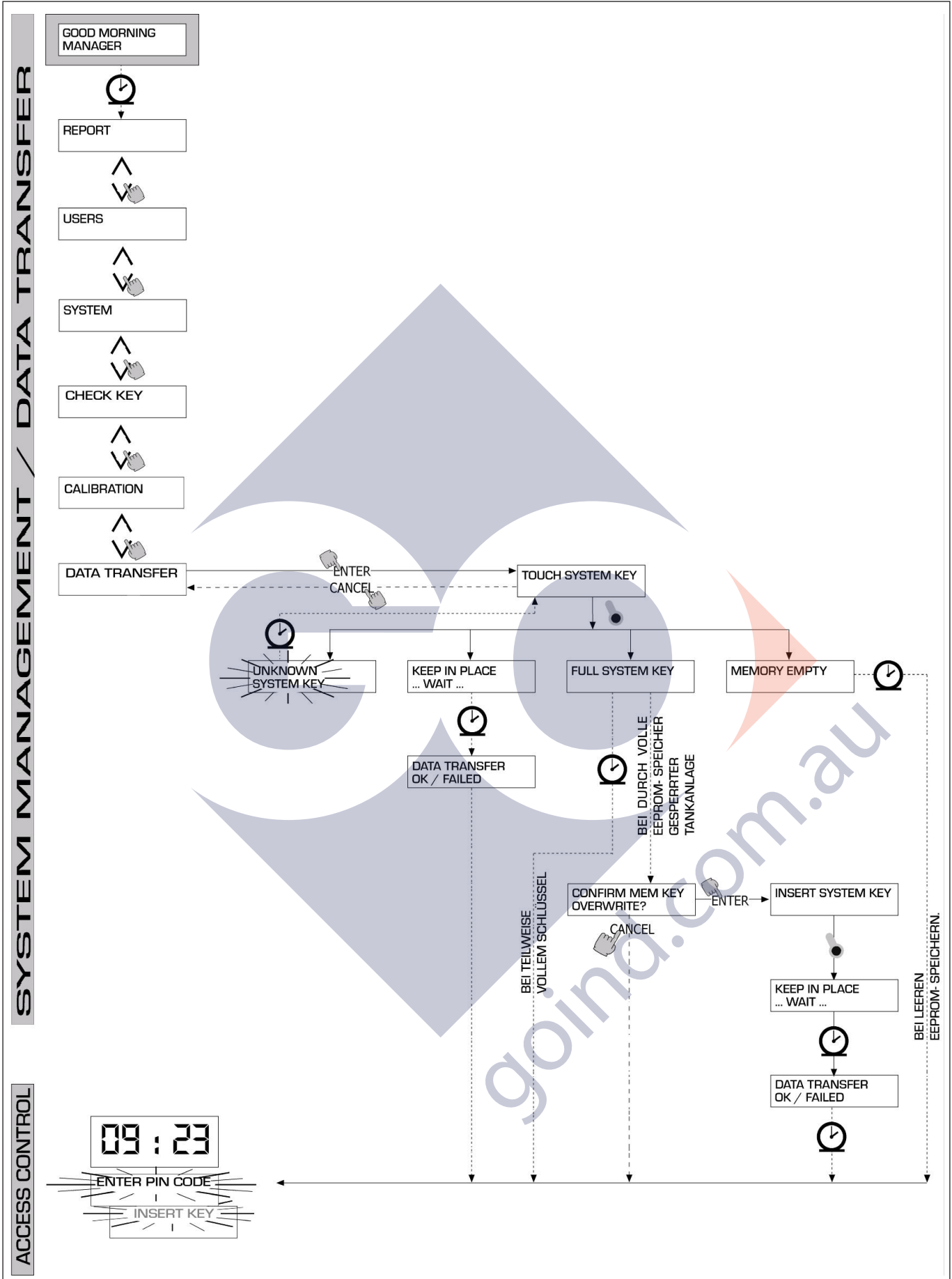

4.7 DISPENSING

DISPENSING allows fuel delivery.

4.7.1 WARNING MESSAGES

As soon as a USER enters his PIN CODE the system changes to ACCESS CONTROL mode, checks if the user is enabled and displays one of the following messages:

- FULL MEMORY

Station memory is full. Dispensing is discontinued.

ATTENTION:

The user should contact the Manager to have dispensing re-enabled. The Manager has two options:
 - if the station is connected by RS 485 line, he can start "SELF SERVICE MANAGEMENT" program and wait for the system to unload data in station memory automatically;
 - he can RESET MEMORY.

- DISPENSING IMPOSSIBLE / MINIMUM LEVEL

Fuel level in tank (controlled by an external level indicator) is below minimum cut-out level. Dispensing is discontinued.

ATTENTION:

The user should contact the Manager to have dispensing re-enabled. The Manager has three options:
 - fill the tank: the level indicator will detect the new level and if the latter is above the minimum cut-out level, dispensing will be re-enabled automatically;
 - reach SYSTEM CONFIGURATION (see paragraph 4.5) and modify LOW LEVEL INPUT parameter from YES (tank level management – available) to NO (tank level management – not available). From now on the level indicator is excluded, dispensing is not inhibited and no alarm in MC system is displayed.
 - reach SYSTEM CONFIGURATION (see paragraph 4.5) and change LOW LEVEL INPUT=ALARM/ PUMP CUT OUT parameter from PUMP CUT OUT (dispensing stopped because of low level) to ALARM (alarm because of low level); in this way a low level warning will still be printed, but dispensing will be re-enabled.

- WRONG CODE

The user has entered a wrong USER PIN CODE, not identified by the station. Dispensing is not allowed. After some minutes the message disappears automatically and the user can repeat his pin code.

- GOOD MORNING "USER"

The user has entered a USER PIN CODE enabled for the station.

The system identifies it and displays the USER name (by which the user has been registered).

4.7.2 OPTIONAL INPUT

Before dispensing, the user can be asked to enter the following data, according to SYSTEM CONFIGURATION:

- REGISTRATION NUMBER

REGISTRATION NUMBER of the vehicle to be supplied with fuel.

10 alphanumeric characters can be entered. The user should enter at least one alphanumeric character to carry out the delivery.

- ODOMETER

ODOMETER VALUE of the vehicle to be supplied with fuel.

6 alphanumeric characters can be entered. The user should enter at least one alphanumeric character to carry out the delivery.

4.7.3 DISPENSING

After the user has been identified and optional data has been entered, the system enables fuel dispensing.

The NUMERIC display changes from visualizing time to dispensed quantity and shows "000.0" or "00.00", depending on the number of decimals selected at configuration stage.

The ALPHANUMERIC display shows USER NUMBER and
 - UNIT of measurement (LITRES or GALLONS, as selected)
 - DISPENSING

flashing alternately.

ATTENTION:

The flashing message DISPENSING means that delivery has been enabled and the pump is ready to start operating as soon as the nozzle is taken out of its seat. After DISPENSING is displayed, a certain time is available for the user to start fuel supply (see START TIME OUT selected at CONFIGURATION stage). Should no delivery be started during this time, the pump is disabled, and the displays show time and request for PIN.

Dispensing can be interrupted and resumed as desired.

However, should the break be longer than a set time (see FILLING TIME OUT set at CONFIGURATION stage), the pump is disabled.

After dispensing the pump is stopped by putting the nozzle back in its seat.

ATTENTION:

If necessary the pump can also be stopped by pressing "STOP" key (without putting the nozzle back).

4.7.4 DISPENSING A PRESET QUANTITY

Before dispensing is started, when the pump has already been enabled and "DISPENSING" is displayed (flashing message), the user can enter a PRESET value using the numeric keyboard.

ATTENTION:

If the decimal point is used, the amount of fuel that can be selected is 1 to 999.9 L/Gal. If the decimal point is not used, the amount of fuel that can be selected is 1 to 9999 L/Gal.

The pump will be momentarily disabled until the typed value is confirmed by pressing "ENTER" key. During dispensing the alphanumeric display will visualise the preset value.

ATTENTION:

Dispensing will be stopped automatically on reaching the pre-set quantity. It will not be possible to resume dispensing manually, because when the pre-set value is reached the pump is disabled.



DISPENSING

ACCESS CONTROL

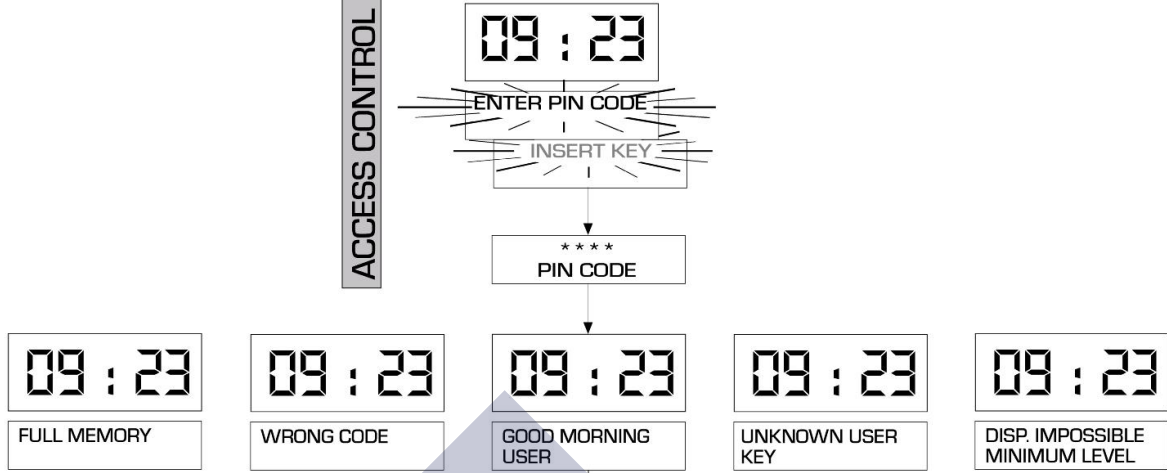

OPTIONAL

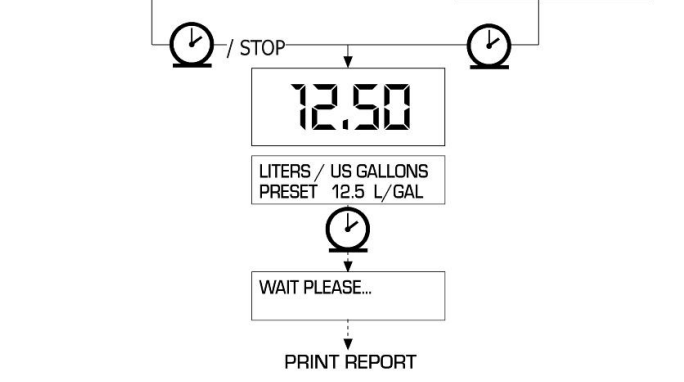
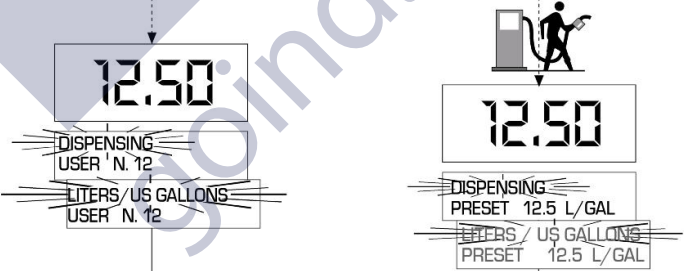
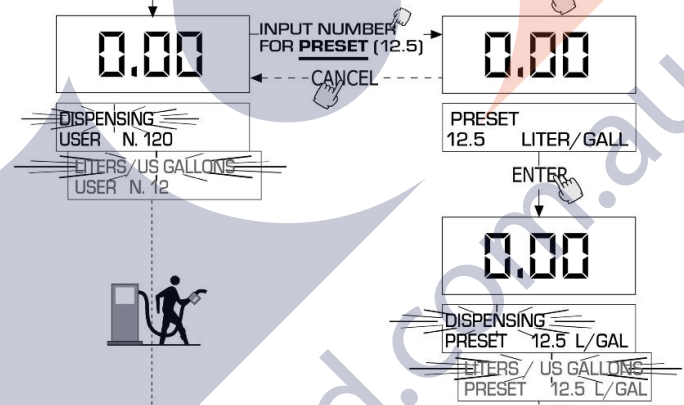
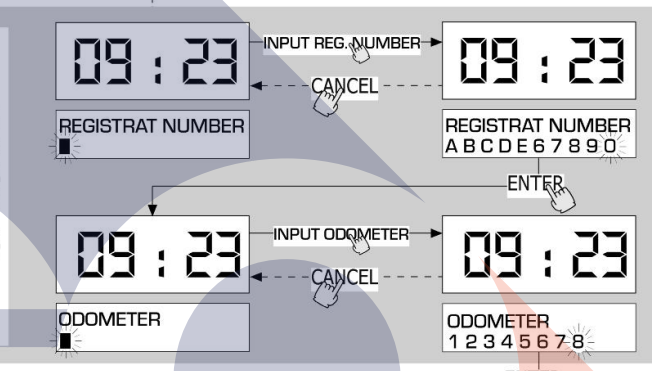

note



goind.com.au

note



goind.com.au

note



goind.com.au

© PIUSI S.p.A.

EN. This document has been drawn up with the greatest attention to precision and accuracy of all data herein contained. Nevertheless, PIUSI S.p.A. denies liability for any possible mistake or omission.

PIUSI
®

*Fluid Handling
Innovation*

piusi.com
PIUSI SpA • Suzzara MN Italy

BULLETIN MOO87 B_00 EN CD